

# SURFACE ROUGHNESS TESTER

This Surface Roughness Tester is small in size, light in weight, easy to carry. Although complex and advanced, it is convenient to use and operate. Its ruggedness will allow many years of use if proper operating techniques are followed. Please read the following instructions carefully and always keep this manual within easy reach.

Cutoff length recommended

Ra ( $\mu\text{m}$ )	Rz ( $\mu\text{m}$ )	Cutoff length (mm)
>5~10	>20~40	2.5
>2.5~5	>10~20	
>1.25~2.5	>6.3~10	0.8
>0.63~1.25	>3.2~6.3	
>0.32~0.63	>1.6~3.2	
>0.25~0.32	>1.25~1.6	0.25
>0.20~0.25	>1.0~1.25	
>0.16~0.20	>0.8~1.0	
>0.125~0.16	>0.63~0.8	
>0.1~0.125	>0.5~0.63	
>0.08~0.1	>0.4~0.5	
>0.063~0.08	>0.32~0.4	
>0.05~0.063	>0.25~0.32	
>0.04~0.05	>0.2~0.25	
>0.032~0.04	>0.16~0.2	
>0.025~0.032	>0.125~0.16	
>0.02~0.025	>0.1~0.125	

\*Metric /Imperial Conversion

## 2. SPECIFICATIONS

Display: 4 digits, 10 mm LCD, with blue backlight

Parameters: Ra, Rz

Display Range

Ra: 0.05-10.00 $\mu\text{m}$ /1.000-400.0 $\mu\text{in}$

Rz: 0.020-100.0 $\mu\text{m}$ /0.780-4000 $\mu\text{in}$

Accuracy: Not more than  $\pm 10\%$

Fluctuation of display value: Not more than 6%

Sensor :

Test Principle: Inductance type

Radius of Probe Pin: 10 $\mu\text{m}$

Material of Probe Pin: Diamond

Measurement Force of Probe: 16mN(1.6gf)

Probe Angle: 90°

Vertical Radius of Guiding Head: 48mm

Maximum driving stroke: 17.5mm/0.7inch

Cutoff length (*l*): 0.25mm / 0.8mm / 2.5mm optional

Evaluation length: 1~5 cut off optional

Driving speed:

sampling length = 0.25mm Vt=0.135mm/s

sampling length = 0.8mm Vt=0.5mm/s

sampling length = 2.5mm Vt=1mm/s

returning Vt=1mm/s

Resolution : 0.001 $\mu\text{m}$  if reading < 10 $\mu\text{m}$

0.01 $\mu\text{m}$  if 10 $\mu\text{m}$   $\leq$  reading < 100 $\mu\text{m}$

0.1 $\mu\text{m}$  if reading  $\geq$  100 $\mu\text{m}$

Power Li-ion battery: rechargeable

Operating conditions: Temp. 0~50°C

Humidity < 80%

Size: 140x57x48 mm (5.5x2.2x1.9 inch)

Weight: about 420 g

# 1.FEATURES

This instrument is compatible with four standards of ISO, DIN, ANSI and JIS and is widely used in production site to measure surface roughness of various machinery-processed parts, calculate corresponding parameters according to selected measuring conditions and clearly display all measurement parameters. When measuring the roughness of a surface, the sensor is placed on the surface and then uniformly slides along the surface by driving the mechanism inside the tester. The sensor gets the surface roughness by the sharp built-in probe. This roughness causes displacement of the probe which results in change of inductive amount of induction coils so as to generate analogue signal, which is in proportion to the surface roughness at output end of phase-sensitive rectifier. The exclusive DSP processes and calculates and then outputs the measurement results on LCD.

- \* Very easy to operate
- \* Multiple parameter measurement: Ra, Rz
- \* Highly sophisticated inductance sensor
- \* Built-in lithium ion rechargeable battery and control circuit with high capacity
- \* Small in size, light in weight and easy to use
- \* Can communicate with PC computer for statistics, printing and analysing by the optional cable and the software for RS232C interface.
- \* Manual or automatic shut down. The tester can be switched off by pressing the Power key at any time. On the other hand, the tester will power itself off about 5 minutes after the last key operation.

## Standard Accessories:

- Carrying case.....1 pc.
- Main unit.....1 pc.
- Standard sensor.....1 pc.
- Standard sample plate.....1 pc.
- Power adapter.....1 pc.
- Operation manual.....1 pc.
- Screwdriver.....1 pc.
- Adjustable leg.....1 pc.
- Sheath of sensor.....1 pc.

## Optional accessories

- Cable & software for RS232C
- Extension rod
- Measurement support

# 3.FRONT PANEL DESCRIPTIONS AND NAMES OF EACH PARTS

## 3.1 Key descriptions

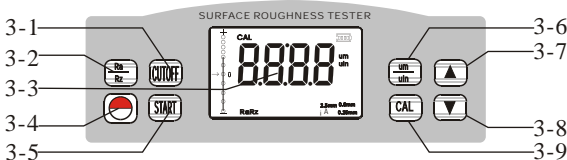
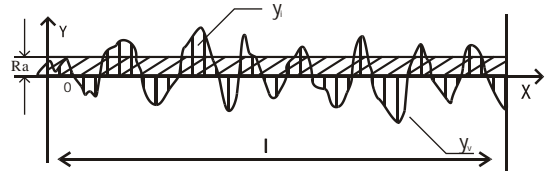

Fig. 3-1

- 3-1 Cutoff key
- 3-2 Parameter key
- 3-3 Display
- 3-4 Power key
- 3-5 Start key
- 3-6 um/inch conversion key
- 3-7 Up key
- 3-8 Down key
- 3-9 Calibration key



## 9.2.2 Rz ten point height of irregularities

The average of the sum of five maximum profile peaks and the average of five maximum profile valleys within the sampling length.

$$Rz = \frac{\sum_{i=1}^5 Y_p + \sum_{i=1}^5 Y_v}{5}$$

## 9.3 Code Standard Name

ISO 4287	International Standard
DIN 4768	German Standard
JIS B601	Japanese Industrial Standard
ANSI B46.1	American Standard

## 9.4 Traversing length

- $L$  = sampling length
- $n$  = number of sampling length
- $l \times n$  = evaluation length

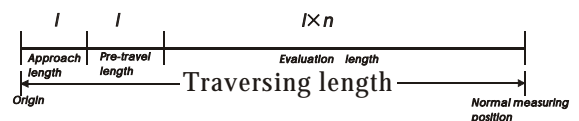

## 9.5 Cutoff length recommended

Please see the table on page 13.

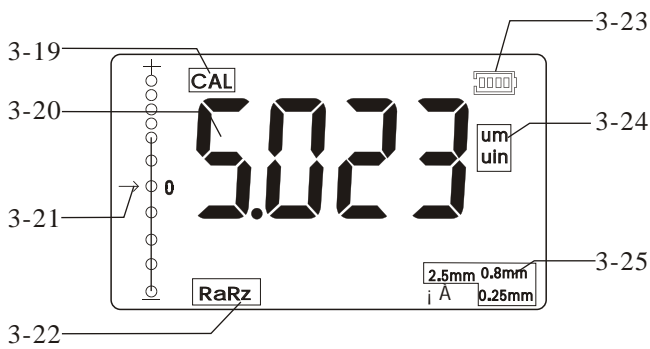

Fig. 3-5

- |                       |              |
|-----------------------|--------------|
| 3-19 Calibration      | 3-23 Battery |
| 3-20 Measurement      | 3-24 Unit    |
| 3-21 Position pointer | 3-25 Cutoff  |
| 3-22 Parameters       |              |

### 3.3 Installation and unloading of sensor



To install, hold the main part of the sensor by hand, push it into connection sheath at the bottom of the instrument as shown in Figure 3-4 and then slightly push to the end of sheath. To unload, hold the main part of sensor or the root of protective sheath and slowly pull it out.

- The probe of the sensor is the main part of this instrument and requires close attention
- During installation and unloading, the probe should not be touched in order to avoid damage which can affect measurement results.
- Connection of the sensor should be reliable during installation.

A. Layout of connection lines should not affect measuring Part while charging.

B. The meanings of battery indicators are:

If battery voltage is normal, measurement can be carried out.

The black part inside prompt shows capacity of Battery;  Indicates too-low voltage and battery should be charged as soon as possible;  indicates that battery is full.

C. Relative high noises of the power source can affect measurement to weak signal to some extent when battery is being charged;

D. The instrument needs to monitor the process of charging so that it is not necessary to turn it off. The instrument will turn on automatically even when switched off.

## 4. MEASURING PROCEDURES

### 4.1 Preparations for measurement

A. Switch on to test if the battery voltage is normal.

B. The instrument automatically restores conditions of the last measurement before it is turned off since these conditions are automatically stored. Before taking measurement, preparations have to be made and checked.

C. To check if the parameter selected is right. If not, depress the key  to select.





D. To check if the cutoff length selected is right. if not, depress the key  to select. For the recommended

### 4.2 Measuring

After preparations is done, just press Start key to measure. If measuring conditions are not to be changed. Firstly, you will see the '---' on the display and the probe is moving forward and sampling. Then you will see the Probe stop sliding and move backward. The measurement result shows on the display after the probe stop moving.

you can browse measurement values of different parameters once depressing the key .

### 5. HOW TO SET THE EVALUATION LENGTH

To set or browse the evaluation length, just depress the  key and not release it until 'LEN' showing on the display. It takes about 6 seconds from starting pressing the key CAL. Then change the evaluation length to the desired length among 1~5L by the key  or . To save or quit, just press any key except the key  or .

### 6. HOW TO CALIBRATE THE TESTER

6.1 To enter the calibration state, just depressing the key , The calibration state is marked by 'CAL'.

6.2 Take a measurement based on the Standard sample. Contrast the measuring value with the value of standard sample plate based on the same parameter.

6.3 Depress the key  or  to adjust the reading to the standard value.

6.4 Just repeat 6.2 to 6.3 till the accuracy is ok.

6.5 To quit, just press any key other than START key.

cut-off length, please see the table in 10.7 on page 13.

E. To check if the measurement unit selected is right. If not, just press the key  to switch between the metric system and the British system.

F. To clear the surface of the part to be measured;

G. Refer to Figure 4-1 and Figure 4-2 to place the instrument correctly, stably and reliably on the surface to be measured.

H. Refer to Figure 4-2, the sliding trail of the sensor must be vertical to the direction of process line of the measured surface.

I. Adjustable leg and sheath of sensor

When the measured surface of the part is smaller than the bottom surface of the instrument, the sheath of sensor and adjustable leg can be used for auxiliary support to complete measurement (as shown in Figure 4-3).

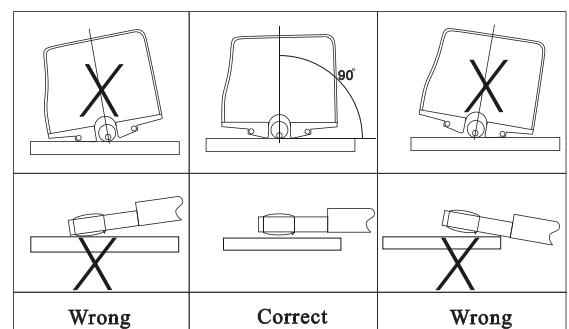

Fig. 4-1

6.6 The instrument has been thoroughly tested before delivery to ensure that the display value error is less than  $\pm 10\%$ . The user is recommended not to use the calibration function too often.

**7. COMMUNICATE WITH PC**

This tester can communicate with PC computer by use of the optional communicating cable and software. For detailed information, please see the instructions with the optional software.

**8. GENERAL MAINTENANCE**

- 8.1 Avoid crashes, intensive vibration, heavy dust, humidity, grease stains and strong magnetic fields;
- 8.2 The sensor is a precise part and should be protected carefully. It is recommended to put it back in the box after each operation;
- 8.3 Protect the standard sample plate belonging to the instrument carefully to avoid calibration faults caused by scratches.

**9. REFERENCES**

**9.1 Central line**

This tester adopts minimum central line of Least Square Algorithm.

**9.2 Definition of roughness parameter**

**9.2.1 Ra arithmetical mean deviation of profile**

Arithmetic value of mean deviation of profile within sampling length.

$$Ra = \frac{1}{n} \sum_{i=1}^n |y_i|$$

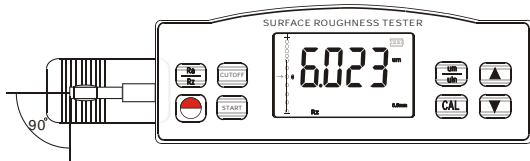

Fig. 4-2

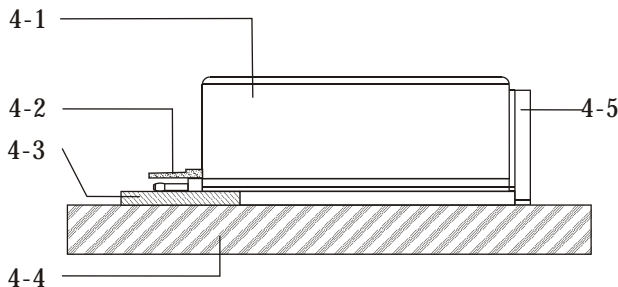

Fig. 4-3

- 4-1 Roughness tester
- 4-2 Sheath of probe
- 4-3 Item to be measured
- 4-4 Working table
- 4-5 Adjustable leg

**3.2 Names of each parts**

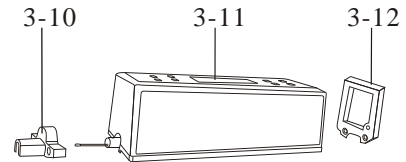

Fig. 3-2

- 3-10 Sheath of probe
- 3-11 Front panel
- 3-12 Adjustable leg

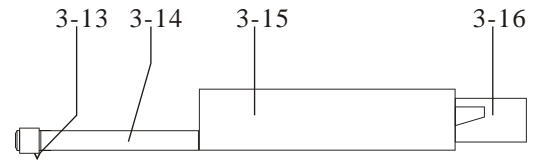

Fig. 3-3

- 3-13 Stylus
- 3-14 Protection sleeve
- 3-15 Main body
- 3-16 Socket

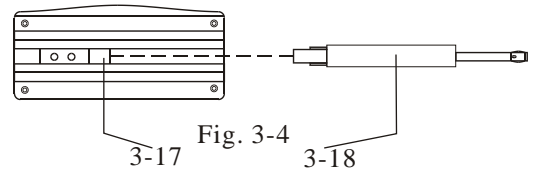

Fig. 3-4

- 3-17 Connection sheath
- 3-18 probe

**3.4 Power adapter and charging of battery**

When the battery voltage is too low (which is indicated by the battery symbol on the screen), the instrument should be charged as soon as possible. Follow the indications shown in Figure 3-6: the power adapter should be plugged into the power socket of the instrument. The power adapter should be connected to 100~220V 50Hz and charging of the battery will begin. Input voltage for power adapter is AC 100~220V with DC 5~7V of output, about 300mA of charging current, charging time of up to 5.0 hours. This instrument uses a lithium ion chargeable battery. Charging can be fulfilled at any time without affecting the normal operation of the instrument.

Figure 3-6

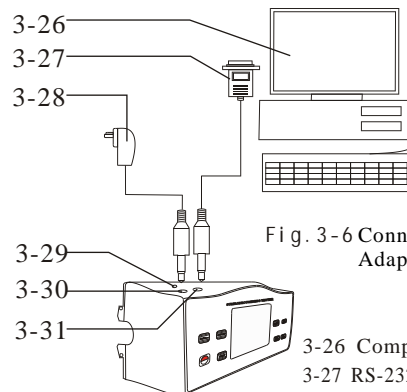

Fig. 3-6 Connection of Power Adapter and RS232C

- 3-26 Computer
- 3-27 RS-232 port to PC COM
- 3-28 Power adapter
- 3-29 Calibration hole
- 3-30 DC power socket
- 3-31 RS-232 socket

**NOTES:**

See next page